

D6025 Series

Size: 60x60x25mm (2.36"x2.36"x0.98")

DIMENSION

HOUSING : Thermoplastic PBT, UL94V-0
 IMPELLER : Thermoplastic PBT, UL94V-0
 BEARING : Sleeve or Ball
 OPERATING TEMPERATURE : Sleeve Bearing:- 10°C to + 70°C
 Ball Bearing:- 30°C to + 75°C
 INSULATION RESISTANCE : 10 meg Ohms Min. @ 500 VDC
 (Between Frame and Terminal)
 DIELECTRIC STRENGTH : 5 mA Max. at 500 VAC 60 Hz
 for 1 minute
 (Between Frame and Terminal)
 WEIGHT : 75g (2.65 oz.)

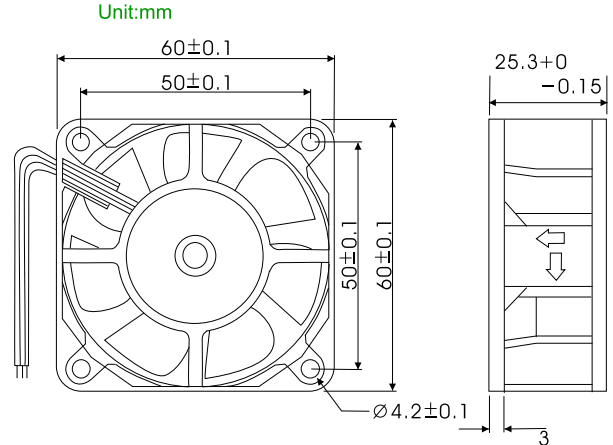

AIR PERFORMANCE

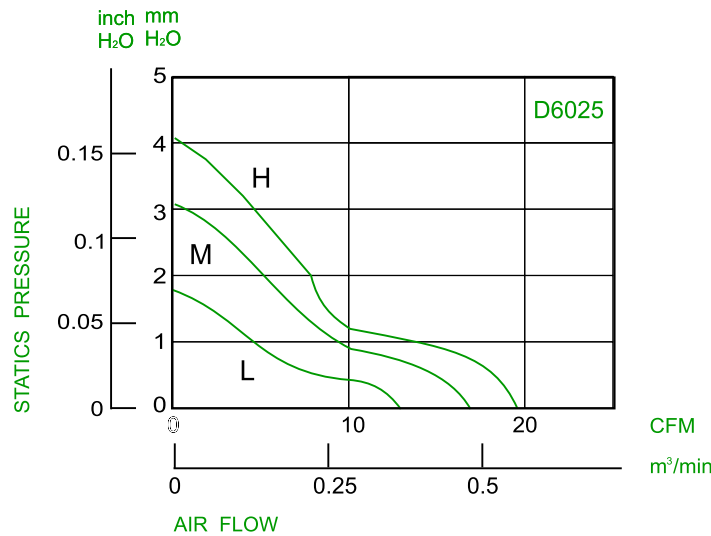

SPECIFICATION

MODEL NO.	RATED VOLTAGE (V)	OPERATING VOLTAGE (V)	RATED CURRENT (A)	INPUT POWER (W)	SPEED (RPM)	MAX. AIR PRESSURE		AIR FLOW		NOISE dB(A) @ 1M
						mmH ₂ O	InchH ₂ O	CFM	m ³ /min	
D6025V12H	12	10.2 - 13.8	0.13	1.56	3800	4.12	0.16	19.5	0.55	30
D6025V12M	12	10.2 - 13.8	0.11	1.32	3200	3.10	0.12	16.7	0.47	25
D6025V12L	12	10.2 - 13.8	0.09	1.08	2600	1.80	0.07	12.8	0.36	23
D6025V24H	24	20.4 - 27.6	0.12	2.88	3800	4.12	0.16	19.5	0.55	30
D6025V24M	24	20.4 - 27.6	0.10	2.40	3200	3.10	0.12	16.7	0.47	25
D68025V24L	24	20.4 - 27.6	0.08	1.92	2600	1.80	0.07	12.8	0.36	23